

Cisco Meraki MS Cloud Managed 10 Gigabit Ethernet Aggregation Switch

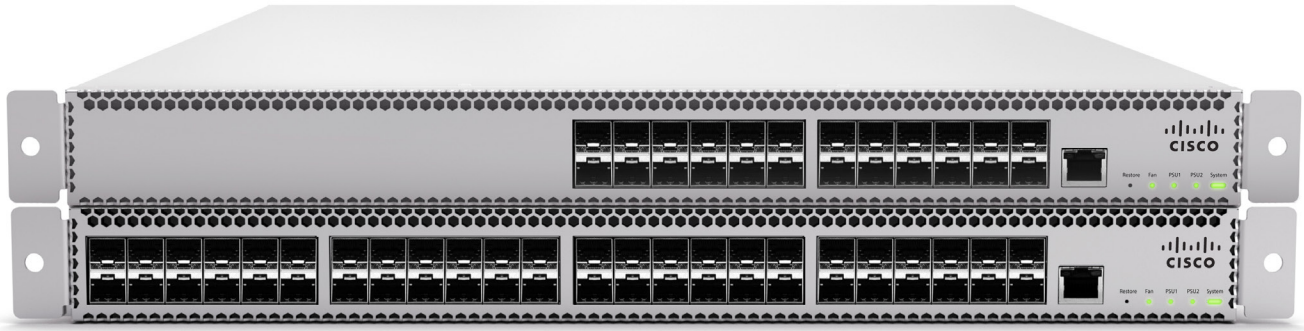

Overview

The Cisco Meraki MS is the world's first cloud-managed 10 Gigabit Ethernet aggregation switch bringing the benefits of the cloud: simplified management, reduced complexity, network wide visibility and control, and lower cost for campus deployments.

Expanding Cloud Management to the Campus

Cisco Meraki aggregation switches extend Meraki's cloud management to campus deployments. Just like our access switches, these 10 Gigabit Ethernet aggregation switches are built from the ground up to be easy to manage without compromising any of the power and flexibility traditionally found in enterprise-class switches.

Meraki switches are managed through an elegant, intuitive cloud interface, rather than a cryptic command line. To bring up a Meraki switch, just plug it in; there's no need for complicated configuration files — or pre-staging.

Industry-Leading Cloud Management

Cloud management has a number of benefits that make it easier to build campus networks:

- Centralized management that allows you to manage your entire Meraki network stack from campus aggregation to your access layer (wireless APs, switches, firewalls).
- Virtual stacking: manage up to tens of thousands of ports from a single pane of glass.
- Layer 7 OS, client, and hostname fingerprinting.
- E-mail and SMS (text) alerts upon power loss, downtime, or configuration changes.
- Role-based administration and automatic, scheduled firmware upgrades over the web.
- Regular feature updates and enhancements delivered on demand from the Meraki cloud.
- No staging deployments

Meraki switches feature high-end hardware features, including:

- Compact, 1RU design for space-constrained environments
- Up to 960 Gbps of non-blocking switching capacity
- Field-replaceable, hot-swappable power supplies
- Field-replaceable, hot-swappable fans
- Front-to-back cooling
- 10/100/1000 RJ-45 management port
- Low power consumption and shallow rack depth, which enable flexible deployment

Full Enterprise Feature Set

- IEEE 802.1X
- Quality-of-Service (QoS)
- DHCP snooping to prevent users from adding unauthorized DHCP servers on the network
- Link Aggregation Control Protocol (LACP) for high-capacity trunking, stacking, and increased availability
- IEEE 802.1Q VLAN tagging
- Port mirroring
- 802.1D Spanning Tree Protocol (STP) and 802.1w Rapid Spanning Tree

Designed for a Complete Cloud-Managed Switch Network

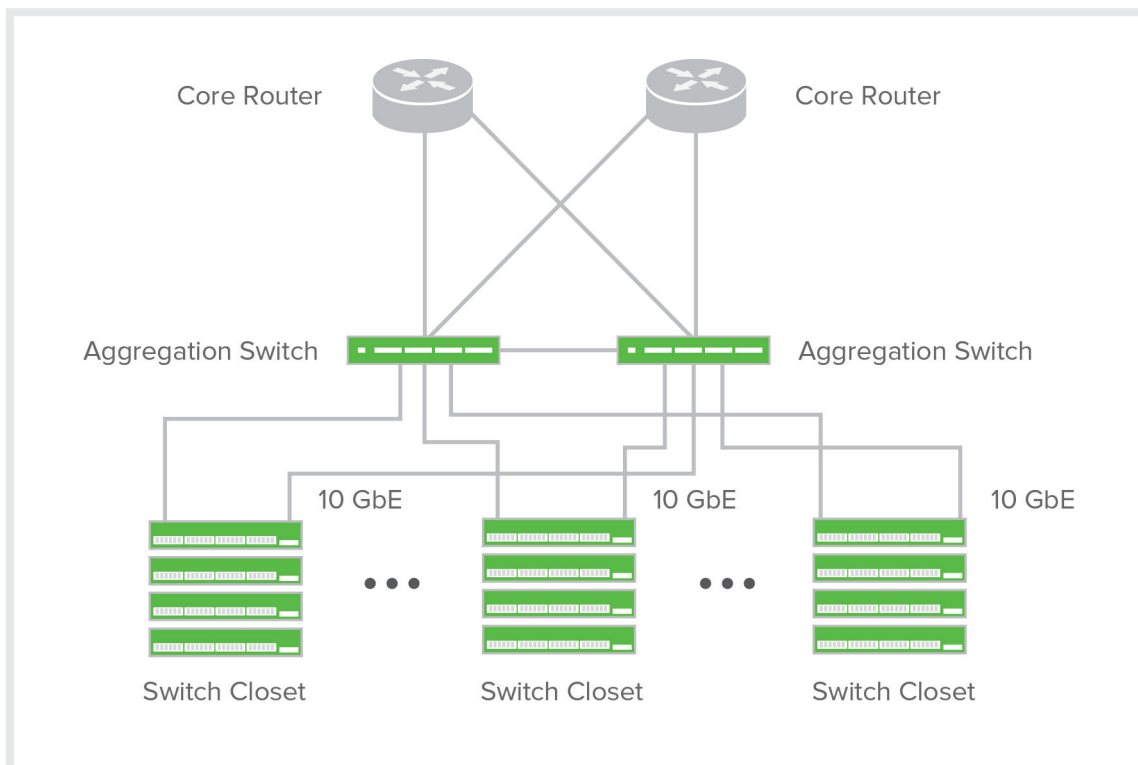

Lifetime Warranty with Next-day Advanced Replacement

Cisco Meraki MS switches include a limited lifetime hardware warranty that provides next-day advance hardware switch replacement as long as the original purchaser owns the product. Meraki's simplified software and support licensing model also combines all software upgrades, centralized systems management and phone support under a single, easy-to-understand model.

For complete details, please visit www.meraki.com/support

Supported Transceivers

The following are SFP transceivers that are supported:

Model	Description	Standard	Range
SFP-1GB-SX	Meraki 1 GbE SFP SX Multi-Mode Fiber Module	1000BASE-SX	550m
SFP-10GB-SR	Meraki 10 GbE SFP+ SR Multi-Mode Fiber Module	10GBASE-SR	400m
CBL-TA-1M	Meraki 10 GbE Twinax Cable with SFP+ Connectors	10GSFP+Cu	1m
SFP-1GB-LX10	Meraki 1 GbE SFP LX10 Single-Mode Fiber Module	1000BASE-LX10	10km
SFP-10GB-LR	Meraki 10 GbE SFP+ LR Single-Mode Fiber Module	10GBASE-LR	10km

Note: Meraki SFP-1GB-SX, SFP-10GB-SR, SFP-1GB-LX10, and SFP-10GB-LR use LC connectors. Meraki does not guarantee third-party optic compatibility and support.

Product Options

Switch models available (see Specifications for additional details):

Model	Description
MS420-24-HW	Cloud-managed 24 port 10 GbE aggregation switch
MS420-48-HW	Cloud-managed 48 port 10 GbE aggregation switch

Specifications (preliminary)

Management

Managed via the Web via the Meraki cloud management platform

Integrated with Meraki wireless, security appliance, and device management No-touch remote deployment (no staging needed)

Detailed historical per-port and per-client usage statistics

DHCP, client, and hostname fingerprinting

SNMPD allows integration with third party network management solutions

Seamless firmware upgrades

Remote Diagnostics

Email and SMS (text) alerts¹

Live remote packet capture

Aggregated event and configuration change logs with instant search

Scalable Stacking

Unified configuration and monitoring of all switches from the aggregation layer to access layer

Virtually Stacking supports thousands of switch ports in a single logical stack for unified management, monitoring, and configuration

Ethernet Switching Capabilities

802.1p Quality of Service prioritization

802.1Q VLAN tagging for up to 4095 VLANs

802.1D Spanning Tree Protocol (STP) and 802.1w Rapid Spanning Tree Broadcast storm control

802.1ab Link Layer Discovery Protocol (LLDP)

802.3ad Link aggregation with up to 8 ports per aggregate

IGMP snooping for multicast filtering

Layer 3 capabilities

Static routing

DHCP helper

DHCP server*

Open shortest path first (OSPF v2)²

Performance

Non-blocking fabric

960 Gbps switching capacity on the MS420-48

480 Gbps switching capacity on the MS420-24

Interfaces on MS420-24-HW

24x 10GbE SFP+/SFP

1x 10/100/1000 RJ45 Management port

Interfaces on MS420-48-HW

48x 10GbE SFP+/SFP

1x 10/100/1000 RJ45 Management port

Power

Power input - 400W AC

Environment

Operating temp: 0C to 40C

Mounting

Rack-mountable with included rack mount hardware

Front-to-back airflow

Physical dimensions

Weight: 18.1 lb. (8.18kg) for MS420-48)

Size: 17.3" (w) x 18.6" (d) x 1.8" (h) (44x 47.3x4.5 cm)

Regulatory

CSA (US)

IC (Canada)

CE (Europe)

C-Tick (Australia/New Zealand)

RoHS

Warranty

Full lifetime hardware warranty with next-day advanced replacement included

Ordering information

This product will be orderable summer 2013. Please contact your Cisco Meraki sales rep for more details.

¹ Requires carrier-supported email to SMS gateway. For more information visit: <http://bit.ly/LIkOSQ>

² Available Q4 CY2013